

CMPH-11
Effective January 2, 2013

CHANNEL & FITTINGS

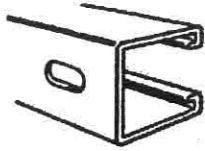

PS 200 EH CHANNEL
1-1/8" x 9/16" ELONGATED
HOLES ON 2" CENTERS
1-5/8" x 1-5/8" x 12 GA.

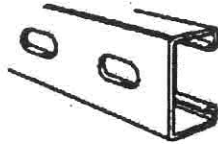

PS 520 EH CHANNEL
1-1/8" x 9/16" ELONGATED
HOLES ON 2" CENTERS
1-5/8" x 13/16" x 12 GA.



PS NS



PS RS



PS 619

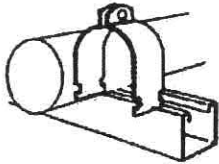

PS 1100

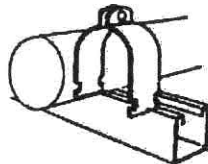

PS 1200

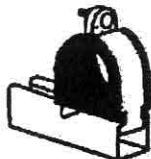

PS 004T

| NUMBER | DESCRIPTION | PRICE | QTY |
|--------|-------------|-------|-----|
|--------|-------------|-------|-----|

CHANNEL

| | | | |
|------------|--------------------------------|----|------|
| PS200EH10G | 15/8 X 15/8 EL HOL GALV 10 FT | FT | 2.87 |
| PS200EH10P | 15/8 X 15/8 EL HOL GRN 10 FT | FT | 2.87 |
| PS200EH20P | 15/8 X 15/8 EL HOL GRN 20 FT | FT | 2.87 |
| PS520EH10P | 15/8 X 13/16 EL HOL GRN 10 FT | FT | 2.79 |
| PS520EH20P | 15/8 X 13/16 EL HOL GRN 20 FT | FT | 2.79 |
| PS520EH10G | 15/8 X 13/16 EL HOL GALV 10 FT | FT | 2.79 |

CHANNEL NUTS

| | | | | |
|---------|--------------------------|----|------|-----|
| PSNS38G | 3/8 CLAMP NUT GAL W/O SP | EA | 1.03 | 100 |
| PSRS38G | 3/8 CLAMP NUT GAL W/SPR | EA | 1.25 | 100 |

SQUARE WASHERS

| | | | | |
|----------|-------------------|----|------|-----|
| PS61938G | 3/8 SQ WASHER GAL | EA | 1.21 | 100 |
|----------|-------------------|----|------|-----|

RIGID STEEL CLAMPS

| | | | |
|------------|----------------------|----|------|
| PS110012G | 1/2 PIPE CLAMP GAL | EA | 1.03 |
| PS110034G | 3/4 PIPE CLAMP GAL | EA | 1.08 |
| PS11001G | 1 PIPE CLAMP GAL | EA | 1.23 |
| PS1100114G | 1 1/4 PIPE CLAMP GAL | EA | 1.38 |
| PS1100112G | 1 1/2 PIPE CLAMP GAL | EA | 1.70 |
| PS11002G | 2 PIPE CLAMP GAL | EA | 1.79 |
| PS11003G | 3 PIPE CLAMP GAL | EA | 2.22 |
| PS11004G | 4 PIPE CLAMP GAL | EA | 2.90 |

COPPER TUBING CLAMPS

| | | | | |
|------------|-----------------------------|----|------|-----|
| PS120038C | 3/8 NOM TUBE CLAMP COP PL | EA | 1.45 | 100 |
| PS120012C | 1/2 NOM TUBE CLAMP COP PL | EA | 1.92 | 100 |
| PS120058C | 5/8 NOM TUBE CLAMP COP PL | EA | 1.95 | 100 |
| PS120034C | 3/4 NOM TUBE CLAMP COP PL | EA | 1.99 | 100 |
| PS12001C | 1 NOM TUBE CLAMP COP PL | EA | 2.32 | 100 |
| PS1200114C | 1 1/4 NOM TUBE CLAMP COP PL | EA | 2.70 | 100 |
| PS1200112C | 1 1/2 NOM TUBE CLAMP COP PL | EA | 2.81 | 100 |
| PS12002C | 2 NOM TUBE CLAMP COP PL | EA | 3.82 | 50 |
| PS1200212C | 2 1/2 NOM TUBE CLAMP COP PL | EA | 2.41 | 50 |

CUSH-A-CLAMP ASSEMBLIES

| | | | | |
|--------|-----------------------|----|-------|----|
| PS004T | 1/4 OD CUSH-A-CLAMP | EA | 2.89 | 25 |
| PS006T | 3/8 OD CUSH-A-CLAMP | EA | 2.89 | 25 |
| PS008T | 1/2 OD CUSH-A-CLAMP | EA | 2.89 | 25 |
| PS010T | 5/8 OD CUSH-A-CLAMP | EA | 2.89 | 25 |
| PS012T | 3/4 OD CUSH-A-CLAMP | EA | 3.02 | 25 |
| PS014T | 7/8 OD CUSH-A-CLAMP | EA | 3.42 | 25 |
| PS018T | 1 1/8 OD CUSH-A-CLAMP | EA | 4.06 | 20 |
| PS022T | 1 3/8 OD CUSH-A-CLAMP | EA | 4.75 | 20 |
| PS026T | 1 5/8 OD CUSH-A-CLAMP | EA | 5.74 | 20 |
| PS034T | 2 1/8 OD CUSH-A-CLAMP | EA | 10.88 | 10 |
| PS050N | 3 1/8 OD CUSH-A-CLAMP | EA | 18.55 | 10 |

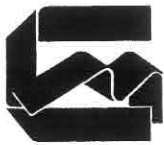

CMPH-11
Effective January 2, 2013

PIPE HANGERS



G-151



G-152

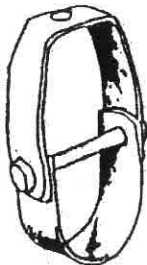

G-442

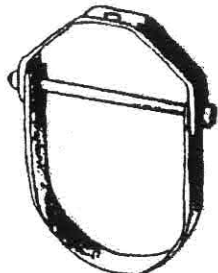

G-450



G-100RC



G-20, G-40

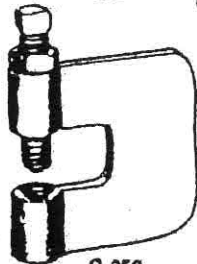

G-250

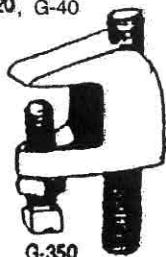

G-350

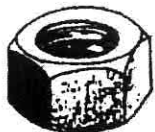

G-110NH

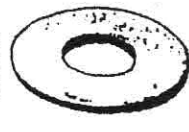

G-130FW



G-940

| NUMBER | DESCRIPTION | PRICE | QTY |
|-----------------------------------|--------------------------|-------|---------|
| GALV ADJ SWIVEL RINGS #151 | | | |
| G-151 1/2 | 1/2 ADJUST SWIVEL RING | EA | .36 100 |
| G-151 3/4 | 3/4 ADJUST SWIVEL RING | EA | .37 100 |
| G-151 1 | 1 ADJUST SWIVEL RING | EA | .37 100 |
| G-151 1 1/4 | 1 1/4 ADJUST SWIVEL RING | EA | .39 100 |
| G-151 1 1/2 | 1 1/2 ADJUST SWIVEL RING | EA | .39 100 |
| G-151 2 | 2 ADJUST SWIVEL RING | EA | .39 100 |
| G-151 2 1/2 | 2 1/2 ADJ SWIVEL RING | EA | .72 50 |
| G-151 3 | 3 ADJUSTABLE SWIVEL RING | EA | .76 50 |
| G-151 4 | 4 ADJUSTABLE SWIVEL RING | EA | 1.26 20 |
| G-151 6 | 6 ADJUSTABLE SWIVEL RING | EA | 2.37 20 |

| NUMBER | DESCRIPTION | PRICE | QTY |
|--------------------------------------|--------------------------|-------|---------|
| COPPER TUBE SWIVEL RINGS #152 | | | |
| G-152 1/2 | 1/2 COPPER SWIVEL RING | EA | .65 100 |
| G-152 3/4 | 3/4 COPPER SWIVEL RING | EA | .65 100 |
| G-152 1 | 1 COPPER SWIVEL RING | EA | .65 100 |
| G-152 1 1/4 | 1 1/4 COPPER SWIVEL RING | EA | .65 100 |
| G-152 1 1/2 | 1 1/2 COPPER SWIVEL RING | EA | .70 100 |
| G-152 2 | 2 COPPER SWIVEL RING | EA | .72 100 |
| G-152 2 1/2 | 2 1/2 COPPER SWIVEL RING | EA | 1.77 20 |
| G-152 3 | 3" COPPER SWIVEL RING | EA | 2.02 50 |
| G-152 4 | 4" COPPER SWIVEL RING | EA | 2.65 20 |

| NUMBER | DESCRIPTION | PRICE | QTY |
|----------------------------------|----------------------------|-------|---------|
| COPPER TUBING CLEVIS #442 | | | |
| G-442 1/2 | 1/2 COPPER CLEVIS HANGER | EA | .84 50 |
| G-442 3/4 | 3/4 COPPER CLEVIS HANGER | EA | .86 50 |
| G-442 1 | 1 COPPER CLEVIS HANGER | EA | .86 50 |
| G-442 1 1/4 | 1 1/4 COPPER CLEVIS HANGER | EA | .93 50 |
| G-442 1 1/2 | 1 1/2 COPPER CLEVIS HANGER | EA | .97 50 |
| G-442 2 | 2 COPPER CLEVIS HANGER | EA | 1.11 50 |

| NUMBER | DESCRIPTION | PRICE | QTY |
|-----------------------------------|-------------------------|-------|---------|
| STANDARD PLAIN CLEVIS #450 | | | |
| G-450 1/2 | 1/2 STD CLEVIS HANGER | EA | .66 50 |
| G-450 3/4 | 3/4 STD CLEVIS HANGER | EA | .75 50 |
| G-450 1 | 1 STD CLEVIS HANGER | EA | .77 50 |
| G-450 1 1/4 | 1 1/4 STD CLEVIS HANGER | EA | .83 50 |
| G-450 1 1/2 | 1 1/2 STD CLEVIS HANGER | EA | .85 50 |
| G-450 2 | 2 STD CLEVIS HANGER | EA | 1.05 50 |
| G-450 2 1/2 | 2 1/2 STD CLEVIS HANGER | EA | 1.18 25 |
| G-450 3 | 3 STD CLEVIS HANGER | EA | 1.97 25 |
| G-450 4 | 4 STD CLEVIS HANGER | EA | 2.46 20 |
| G-450 6 | 6 STD CLEVIS HANGER | EA | 4.35 10 |

| NUMBER | DESCRIPTION | PRICE | QTY |
|---|-------------------------------|-------|---------|
| ZINC PLATED THREADED ROD & COUPLINGS | | | |
| G-100RC | 3/8 STD ROD CPLG | EA | .19 100 |
| G-40 | 3/8 x 10" THREADED ROD 16 Ga. | EA | 4.10 25 |
| G-20 | 3/8X6' THREADED ROD | EA | 2.48 38 |

| NUMBER | DESCRIPTION | PRICE | QTY |
|--------------------------------------|----------------------|-------|----------|
| C-CLAMP/BEAM CLAMPS W/LOCKNUT | | | |
| G-250 3/8 | C-CLAMP W/LOCKNUT | EA | 2.76 100 |
| G-350 3/8 | BEAM CLAMP W/LOCKNUT | EA | 1.04 100 |

| NUMBER | DESCRIPTION | PRICE | QTY |
|-----------------------------|-------------------------|-------|----------|
| NUTS/WASHERS/FLANGES | | | |
| G-110HN | 3/8 STD HEX NUT | EA | .04 100 |
| G-130FW | 3/8 STD FLAT WASHER | EA | .06 100 |
| G-940 | 3/8 IRON CEILING FLANGE | EA | 1.09 100 |

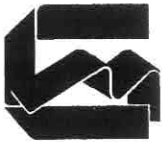

CMPH-11
Effective January 2, 2013

PIPE HANGERS

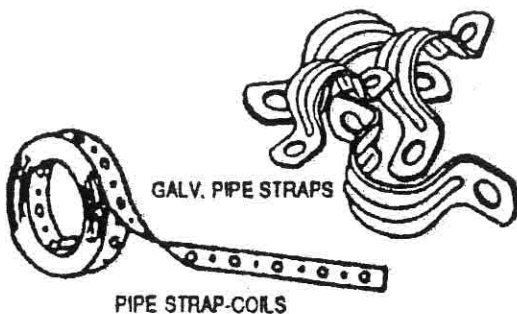
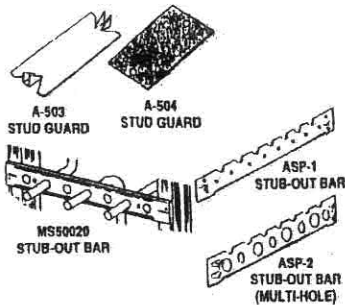
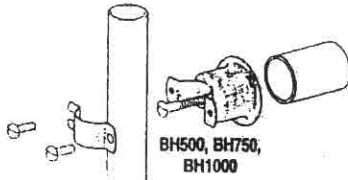
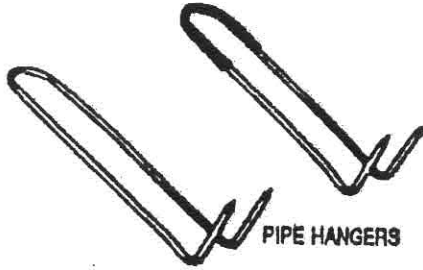

| NUMBER | DESCRIPTION | PRICE | QTY |
|--------|-------------|-------|-----|
|--------|-------------|-------|-----|

PIPE HANGERS-PLAIN STEEL/PLAS COAT

| | | | | |
|-------|------------------------|----|-----|----|
| A5726 | 1/2 X 6 PIPE HANGER PC | EA | .40 | 50 |
| A5734 | 3/4 X 4 PIPE HANGER PC | EA | .39 | 50 |
| A5736 | 3/4 X 6 PIPE HANGER PC | EA | .42 | 50 |
| A5746 | 1 X 6 PIPE HANGER PC | EA | .48 | 50 |

PIPE HANGERS-11GA PLAIN STEEL

| | | | | |
|--------|---------------------|----|-----|----|
| A5736S | 3/4 X 6 PIPE HANGER | EA | .16 | 50 |
| A5746S | 1 X 6 PIPE HANGER | EA | .16 | 50 |

BELL HANGERS

| | | | | |
|--------|------------------|----|------|----|
| BH500 | 1/2" BELL HANGER | EA | .97 | 25 |
| BH750 | 3/4" BELL HANGER | EA | .98 | 25 |
| BH1000 | 1" BELL HANGER | EA | 1.01 | 25 |

COPPER PIPE HANGERS

| | | | | |
|--------|---------------------|----|-----|----|
| A5732C | 3/4X2 1/2 PIPE HOOK | EA | .13 | 50 |
| A5726C | 1/2X6 COPPER HANGER | EA | .18 | 50 |
| A5736C | 3/4X6 COPPER HANGER | EA | .19 | 50 |
| A5746C | 1X6 COPPER HANGER | EA | .19 | 50 |

ELITE STUD GUARDS

| | | | | |
|---------|----------------------------|----|-----|-----|
| A503-3 | 1-1/2 X 3 16 GA STUD GUARD | EA | .13 | 100 |
| A503-16 | 1-1/2 X 6 16 GA STUD GUARD | EA | .22 | 100 |
| A503 | 1-1/2 X 6 18 GA STUD GUARD | EA | .18 | 100 |

ELITE COPPER COAT STUB OUT BAR

| | | | | |
|---------|------------------------------------|----|------|----|
| ASP-1 | STUB-OUT BAR 5/8 OD X 18" | EA | 1.96 | 50 |
| ASP-2 | STUB-OUT BAR MULTI HOLE SIZE X 18" | EA | 2.26 | 50 |
| MS50020 | 1/2" STUB-OUT BAR X 20" | EA | 2.15 | 50 |

GALV 2-HOLE PIPE STRAP W/NAILS

| | | | | |
|-------------|-----------------------|----|-----|-----|
| G-440 1/2 | 1/2 GALV PIPE STRAP | EA | .07 | 100 |
| G-440 3/8 | 3/8 GALV PIPE STRAP | EA | .06 | 100 |
| G-440 3/4 | 3/4 GALV PIPE STRAP | EA | .09 | 100 |
| G-440 1 | 1 GALV PIPE STRAP | EA | .13 | 100 |
| G-440 1 1/4 | 1 1/4 GALV PIPE STRAP | EA | .24 | 50 |
| G-440 1 1/2 | 1 1/2 GALV PIPE STRAP | EA | .26 | 50 |
| G-440 2 | 2 GALV PIPE STRAP | EA | .28 | 50 |

PIPE STRAP COILS 24GA

| | | | | |
|-----------|-----------------------------|----|-------|----|
| APS24 | 3/4 GALV STRAP - 10' | EA | 1.22 | 10 |
| APS24-100 | 3/4 GALV STRAP - 100' | EA | 12.09 | 1 |
| APS24-C | COPPER COATED STRAP - 10' | EA | 2.44 | 10 |
| DS24 | DUCT STRAP 24 GA. 3/4 X 10' | EA | 1.22 | 10 |

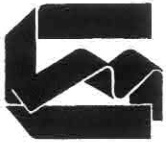

CMPH-11
Effective January 2, 2013

PIPE HANGERS

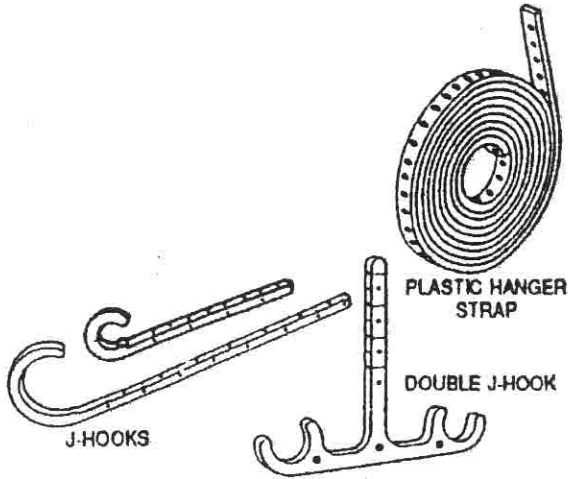

| NUMBER | DESCRIPTION | PRICE | QTY |
|-----------------------------|------------------------------|---------|-----|
| PLASTIC HANGER STRAP | | | |
| JHK-100 | 3/4 PLASTIC HANGER STRAP-100 | EA 7.34 | 10 |

J-HOOK PVC PIPE HANGERS

| | | | |
|---------|----------------------|--------|----|
| SH500 | 1/2 CTS PVC J-HOOK | EA .42 | 25 |
| SH750 | 3/4 CTS PVC J-HOOK | EA .45 | 25 |
| SH1000 | 1 CTS PVC J-HOOK | EA .46 | 25 |
| RH1500 | 1 1/2 NOM PVC J-HOOK | EA .55 | 25 |
| RH2000 | 2 NOM PVC J-HOOK | EA .59 | 25 |
| RH3000 | 3 NOM PVC J-HOOK | EA .65 | 25 |
| RH4000 | 4 NOM PVC J-HOOK | EA .71 | 25 |
| AJJ500 | 1/2X1/2 PVC DBL HOOK | EA .83 | 25 |
| AJJ5075 | 1/2X3/4 PVC DBL HOOK | EA .92 | 25 |
| AJJ5075 | 1/2X3/4 PVC DBL HOOK | EA .92 | 25 |

PVC SWIVEL HANGERS

| | | | |
|------|----------------------|--------|----|
| SH-2 | 2" PVC SWIVEL HANGER | EA .85 | 25 |
| SH-3 | 3" PVC SWIVEL HANGER | EA .90 | 25 |

ALL STAINLESS HOSE CLAMPS

| | | | |
|-----------|---------------------------------------|---------|----|
| ABG51C | 1/4" STAINLESS HOSE CLAMP 04 (62602) | EA .75 | 10 |
| ABG51E | 3/8" STAINLESS HOSE CLAMP 06 (62606) | EA .75 | 10 |
| ABG51E-WB | 9/16" WIDE BAND | EA .90 | 10 |
| ABG51F | 1/2" STAINLESS HOSE CLAMP 08 (62M08) | EA .87 | 10 |
| ABG51F-WB | 9/16" WIDE BAND | EA .90 | 10 |
| ABG51K | 3/4" STAINLESS HOSE CLAMP 10 (6810) | EA .90 | 10 |
| ABG51M | 1" STAINLESS HOSE CLAMP 12 (6812) | EA .92 | 10 |
| ABG51Q | 1 1/4" STAINLESS HOSE CLAMP 16 (6816) | EA .92 | 10 |
| ABG51R | 1 1/2" STAINLESS HOSE CLAMP 20 (6820) | EA .94 | 10 |
| ABG51S | 2" STAINLESS HOSE CLAMP 24 (6824) | EA .94 | 10 |
| ABG51T | 2 1/2" STAINLESS HOSE CLAMP 32 (6832) | EA .94 | 10 |
| ABG51-28 | 2 1/4" STAINLESS HOSE CLAMP (6828) | EA .94 | 10 |
| ABG51-36 | 2 3/4" STAINLESS HOSE CLAMP (6836) | EA .99 | 10 |
| ABG51-40 | 3" STAINLESS HOSE CLAMP (6840) | EA 1.09 | 10 |
| ABG51-56 | 4" STAINLESS HOSE CLAMP (6856) | EA 1.32 | 10 |
| ABG51-64 | 4 1/2" STAINLESS HOSE CLAMP (6864) | EA 1.46 | 10 |
| ABG51-72 | 5" STAINLESS HOSE CLAMP (6872) | EA 1.52 | 10 |

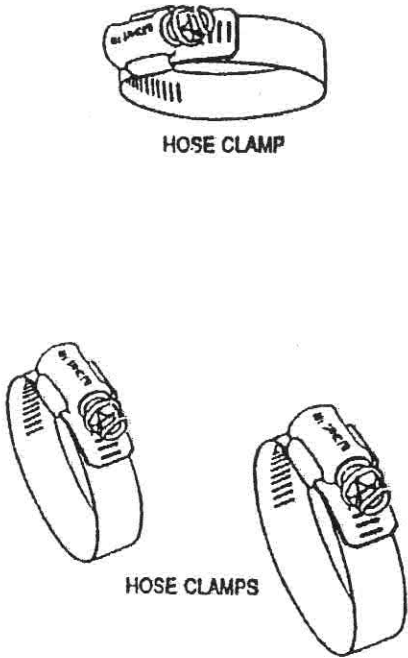

HOSE CLAMPS

| | | | |
|--------|-----------------------------|--------|----|
| ABG50E | 3/8" HOSE CLAMP 06 (6203) | EA .55 | 10 |
| ABG50F | 1/2" HOSE CLAMP 08 (62P08) | EA .58 | 10 |
| ABG50K | 3/4" HOSE CALMP 10 (5010) | EA .69 | 10 |
| ABG50M | 1" HOSE CLAMP 12 (5012) | EA .71 | 10 |
| ABG50Q | 1 1/4" HOSE CLAMP 14 (5016) | EA .71 | 10 |